

RESILIENT INSTALLATION GUIDELINES FOR WPC PRODUCTS WITH 5G FOLD

I. GENERAL INFORMATION

These installation guidelines apply only to the WPC products with 5G Fold system. All instructions and recommendations should be followed for a satisfactory installation.

- Acclimation of material prior to installation is not required, however, the floor covering should be installed in a climate controlled environment with an ambient temperature range between 55°F- 85°F (13°C-29°C) or average temperature of 70°F degrees (21.1°C).
- For installations involving 3 season scenarios, meaning, the dwelling or installed space is without climate control for extended periods during certain seasons of the year, the post installation temperature range allowed is an ambient room temperature between 32°F and 100°F (0°C- 37.7°C). This allowance is for floating floors only and does not apply to glue-down installations.
- Avoid exposure to direct sunlight for prolonged periods, doing so may result in discoloration. During peak sunlight hours, the use of drapes or blinds is recommended. Excess temperature due to direct sunlight can result in thermal expansion and UV fading.
- Install product after all other trades have completed work that could damage the flooring.
 - If cabinets are to be installed on top of the flooring (including islands), that area of material must be fully adhered to the subfloor (including an additional 2'ft beyond the cabinets and islands).
- To minimize shade variation, mix and install planks from several cartons.
- Inspect all planks for damage before installing. If you have any concerns about the product fit or finish, call Shaw Information Services at 1-800-441-7429. Claims will not be accepted for flooring that has been cut to size and/or installed.
- Use cementitious patching and leveling compounds that meet or exceed maximum moisture level and pH requirements. Use of gypsum-based patching and/or leveling compounds which contain Portland or high alumina cement and meet or exceed the compressive strength of 3,000 psi are acceptable.
- Installation Methods: Floating (on, above or below grade) / Glue Down (on, above or below grade)
- Required perimeter expansion spacing for Floating or Glue Down installation is as follows:
 - For areas less than 2500 sq ft, use 1/4" gap
 - For areas larger than 2500 sq ft. use 1/2" gap.
- WPC flooring is waterproof and reliably secures the flooring panels on all four sides. However, excessive moisture in the subfloor could promote mold, mildew, and other moisture related issues like the trapping of moisture emissions under the flooring, which may contribute to an unhealthy indoor environment.
- Additional layer of minimum 6 mil poly film or equal vapor retarder with a perm rating of .1 or less may be used as an additional layer of protection.

II. SUBFLOOR INFORMATION

All subfloors must be clean, flat, dry and structurally sound. The correct preparation of the subfloor is a major part of a successful installation. Subfloor must be flat – 3/16" in 10' or 1/8" in 6'.

A. WOOD SUBFLOORS

Do not install material over wood subfloors that lay directly on concrete or over dimensional lumber or plywood used over concrete. Refer to ASTM F1482 for panel underlayment recommendations.

All other subfloors - Plywood, OSB, particleboard, chipboard, wafer board, etc. must be structurally sound and must be installed following their manufacturer's recommendations. Local building codes may only establish minimum requirements of the flooring system and may not provide adequate rigidity and support for proper installation and performance. If needed add an additional layer of APA rated underlayment, fasten and secure according to the underlayment manufacturer's recommendations.

1. Do not apply sheet plastic over wood subfloors.

2. Basements and crawl spaces must be dry. Use of a 6 mil black polyethylene is required to cover 100% of the crawl space earth. Crawl space clearance from ground to underside of joist is to be no less than 18" and perimeter vent spacing should be equal to 1.5% of the total square footage of the crawl space area to provide cross ventilation. Where necessary, local regulations prevail.
3. **DO NOT** install over sleeper construction subfloors or wood subfloors applied directly over concrete.
4. Resilient flooring is not recommended directly over fire-retardant treated plywood or preservative treated plywood. An additional layer of APA rated 1/4" thick underlayment should be installed.

B. Concrete Subfloors

NEW AND EXISTING CONCRETE SUBFLOORS SHOULD MEET THE GUIDELINES OF THE LATEST EDITION OF ACI 302 AND ASTM F 710, "STANDARD PRACTICE FOR PREPARING CONCRETE FLOORS TO RECEIVE RESILIENT FLOORING" AVAILABLE FROM THE AMERICAN SOCIETY FOR TESTING AND MATERIALS, 100 BARR HARBOR DRIVE, WEST CONSHOHOCKEN, PA 19428; 610-832-9585; [HTTP://WWW.ASTM.ORG](http://www.astm.org).

- Floors shall be smooth, permanently dry, clean, and free all foreign material such as dust, wax, solvents, paint, grease, oils, and old adhesive residue. The surface must be hard and dense, and free from powder or flaking.
- If the adhesive residue is asphalt-based (cut-back), or any other type of adhesive is present, it must be removed by industry accepted methods such as mechanical removal or wet scraping.
- If a chemical abatement has been performed, use Shaw Surface Prep EXT to remove any residual chemicals present. Once Shaw Surface Prep EXT has been properly cleaned and removed, apply one coat of Shaw MRP for additional protection.
- Adhesive removal through the use of solvents or citrus adhesive removers is not recommended. Solvent residue left in or on the subfloor may affect the new adhesive and floor covering.

WARNING! DO NOT SAND, DRY SWEEP, DRY SCRAPE, DRILL, SAW, BEAD BLAST OR MECHANICALLY CHIP OR PULVERISE EXISTING RESILIENT FLOORING, BACKING, LINING FELT, ASPHALTIC "CUT BACK" ADHESIVES OR OTHER ADHESIVES.

These products may contain either asbestos fibers and/or crystalline silica. Avoid creating dust. Inhalation of such dust is a cancer and respiratory tract hazard. Smoking by individuals exposed to asbestos fibers greatly increases the risk of serious bodily harm. Unless positively certain that the product is a non-asbestos-containing material, you must presume it contains asbestos. Regulations may require that the material be tested to determine asbestos content and may govern the removal and disposal of material. See current edition of the Resilient Floor Covering Institute (RFCI) publication Recommended Work Practices for Removal of Resilient Floor Coverings for detailed information and instructions on removing all resilient covering structures. For current information go to www.rfci.com.

- Concrete slabs must be dry with no visible moisture.
- Required Moisture Testing - maximum moisture level per ASTM 1869 CaCl is 8 lbs. and ASTM 2170 In-situ Relative Humidity 90% per 1000 sq.ft. in 24 hours.
- Do not install over concrete with a history of high moisture or hydrostatic conditions. Excessive moisture in the subfloor could promote mold, mildew, and other moisture related issues like the trapping of moisture emissions under the flooring, which may contribute to an unhealthy indoor environment. Shaw Industries does not warrant nor is responsible for damage to floor covering due to moisture related issues.
- pH level of concrete should be between 7-10.
- The final responsibility for determining if the concrete is dry enough for installation of the flooring lies with the floor covering installer.

NOTE: IT MAY NOT BE THE FLOOR COVERING INSTALLER'S RESPONSIBILITY TO CONDUCT THESE TESTS. IT IS, HOWEVER, THE FLOOR COVERING INSTALLER'S RESPONSIBILITY TO MAKE SURE THESE TESTS HAVE BEEN CONDUCTED, AND THAT THE RESULTS ARE ACCEPTABLE PRIOR TO INSTALLING THE FLOOR COVERING. WHEN MOISTURE TESTS ARE CONDUCTED, IT INDICATES THE CONDITIONS ONLY AT THE TIME OF THE TEST.

LIGHTWEIGHT CONCRETE

All recommendations and guarantees as to the suitability and performance of lightweight concrete under resilient flooring are the

responsibility of the lightweight concrete manufacturer. The installer of the lightweight product may be required to be authorized or certified by the manufacturer. Correct on-site mixing ratios and properly functioning pumping equipment are critical. To ensure proper mixture, slump testing is recommended.

- Lightweight aggregate concretes having dry densities greater than 90 lbs. per cubic foot may be acceptable under resilient flooring.
- Concrete slabs with heavy static and/or dynamic loads should be designed with higher strengths and densities to support such loads.
- Surface must be permanently dry, clean, smooth, free of all dust, and structurally sound.
- Perform Bond testing to determine compatibility of adhesive to the substrate. Shaw 9050 primer can be utilized to promote adhesion.
- Three internal relative humidity tests should be conducted for areas up to 1000 SF. One additional test, for each additional 1000 SF.

Radiant Heating: Radiant-heated subfloor systems can be concrete, wood or a combination of both.

The heating systems components must have a minimum of 1/2" separation from the flooring product. The system must be on and operational for at least 2 weeks prior to installation to reduce residual moisture. Three days prior to installation lower the temperature to 65 degrees, after installation gradually increase the temperature in increments of 5° F to avoid overheating. Maximum operating temperature should never exceed 85°F. Use of an in-floor temperature sensor is recommended to avoid overheating. Contact the manufacturer of your radiant heating system for further recommendations.

- *Electric Radiant Floors:* consist of electric cables (or) mats of electrically conductive materials mounted on the subfloor below the floor covering. Mesh systems are typically embedded in thin-set. When embedding the system components, use cementitious patching and leveling compounds that meet or exceed Shaw's maximum moisture level and pH requirements. Use of gypsum-based patching and/or leveling compounds which contain Portland or high alumina cement and meet or exceed the compressive strength of 3,000 psi are acceptable.
- *Hydronic Radiant Floors:* pump heated water from a boiler through tubing laid in a pattern under the flooring. Typically installed in channels under a wooden subfloor (or) imbedded in concrete slabs.

C. EXISTING FLOOR COVERINGS

Flooring can be installed over most existing hard-surface floor coverings, provided that the existing floor surface is fully adhered, clean, flat dry structurally sound and free of deflection.

- Existing sheet vinyl floors should not be heavily cushioned and not exceed more than one layer in thickness. Soft underlayment and soft substrates will compromise the product's locking ability as well as diminish its indentation resistance.
- Installation is NOT allowed over any type of carpet.
- Do NOT install over wood floors adhered to concrete.
- This product can be installed over existing ceramic/porcelain tile products with up to a 1/4 inch wide grout joint. If the grout joint width exceeds 1/4 inch, a cementitious patching compound should be used to fill the grout joint to make it smooth with the surface of the tile.

III. INSTALLATION

Tools: Tape Measure, Utility Knife, Jigsaw, Tapping Block or Rubber Mallet, Pull Bar, ¼" Spacers, T-Square, Safety Glasses, Broom or Vacuum and, if necessary, tools for subfloor repair.

Floating Installation

This flooring is designed to be installed utilizing the floating method. Proper expansion space 1/4" (6.35 mm) is required. Undercut all doorjamb. Do not fasten wall moldings and or transition strips to the planks.

Glue Down Installation: WPC products are approved for glue down installation over approved wood and concrete substrates.

Follow adhesive label application instructions. Install flooring into wet adhesive to achieve a permanent bond. Maintain 1/4" (6.35 mm) perimeter expansion space. Refer to adhesive label for moisture limits of the adhesive. Roll flooring immediately after installation with a 100 lbs. 3-section roller

- Recommended Adhesive: Shaw 200 or comparable adhesive.

Tile patterns must be installed in a staggered (offset) brick pattern. Minimum 1/3 offset 1/2 offset is preferred.

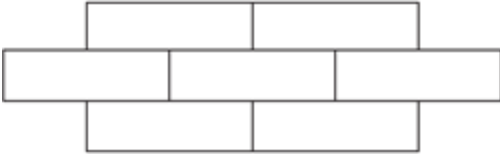

PREPARATION

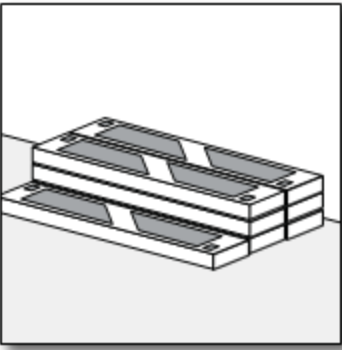

Do not store cartons near heating/cooling ducts or direct sunlight.



Undercut doorjamb for a professional fit.



Roll out just enough underlayment for the next few rows of planks you are installing.

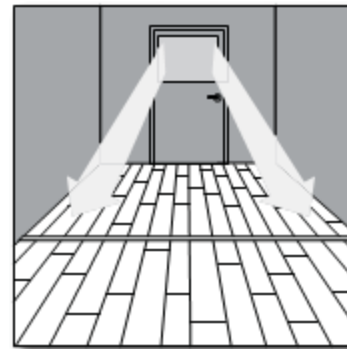

Try to run planks parallel to main light source.

INSTALLATION

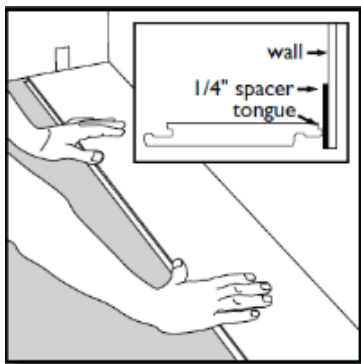

Begin the installation in the left-hand corner. Place the plank a minimum of 1/4" from the left wall.

Use the installation spacers throughout all perimeter areas to insure the correct expansion space is maintained.

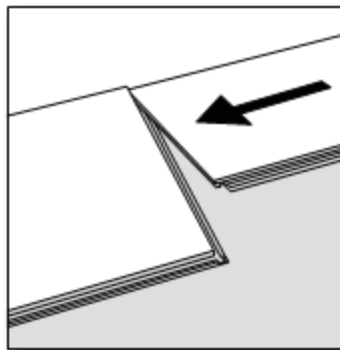

In the first row, place the second plank tight against the short end of the first plank.

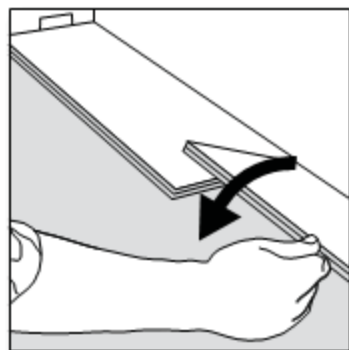

Fold down into the locked position with a single movement.

The 5G fold will engage to lock this plank into place.

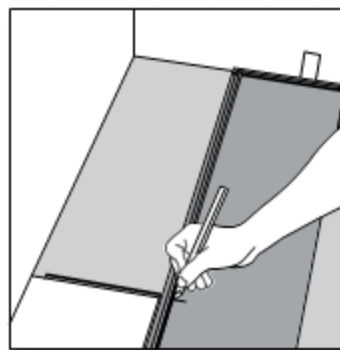

Place the final plank face down with the short side (without the locking strip) towards the wall. The remaining expansion space should be a minimum 1/4" from the wall. Draw a pencil line where the plank is to be cut.

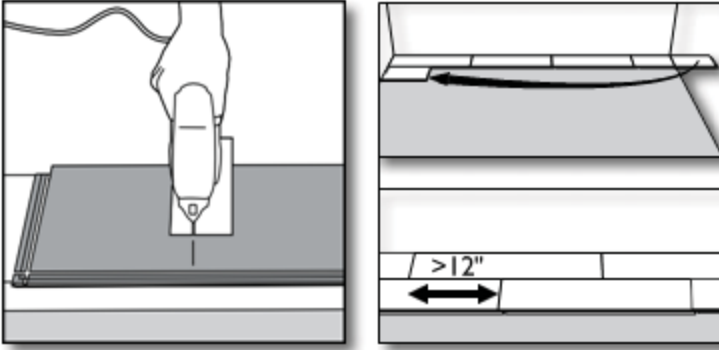

Place the plank face down on the work surface and cut to size with a power saw. If you are using a hand saw, use a fine-toothed blade, and cut the planks face up. The score/snap method (using a square or straightedge) requires the pad be cut from the back side using a utility blade (either before or after the score/snap).

Use a cut piece of board from the previous row to start the next row. This starting plank section must be at least 8" long. If the piece is too short, start with a new board. Cut the new board in one third, one half or two thirds length sections, depending upon what is required to maintain the random stagger from one row to the next. Always ensure that the end joints are staggered a minimum of 8 inches from one row to the next.

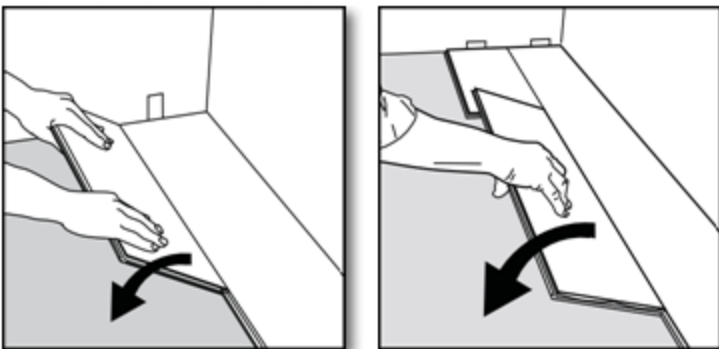

Place the plank at an angle against the plank in the previous row, press the edge forward against the previous row and fold down at the same time.

Connect the plank in the following rows by aligning the end seam of each plank directly above the end seam of the preceding plank. Insert the long side seam at a slight angle first and as the top surfaces meet, rotate the plank down into the locked position.

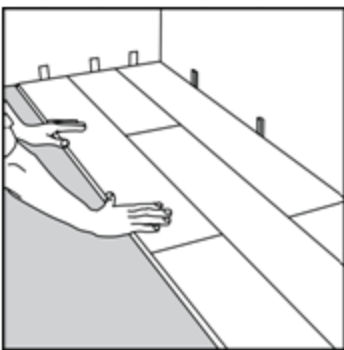

The distance to the walls can be adjusted when three rows have been completed. Remember to place the flooring a minimum of 1/4" from all walls or other vertical obstructions such as cabinets, pipes, or columns.

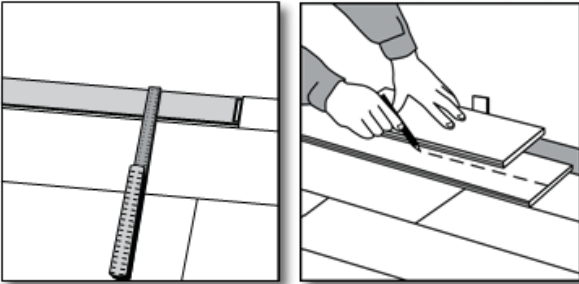

Measure and cut the last row to fit, remember to allow for a minimum of 1/4" expansion space from the wall. Use a full width scrap plank to mark your cutting on the last row.

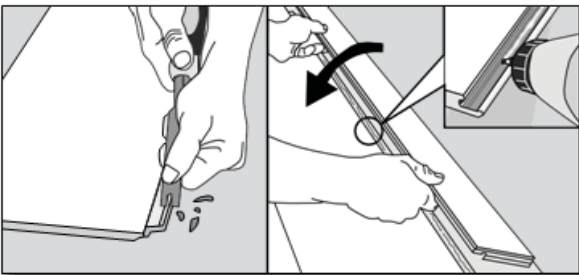

In areas such as a doorjamb or cabinet kick base where planks cannot be angled to lock into place, use a wood chisel to remove the locking ridge from the bottom of the plank groove.

Apply a 1/8" bead of cyanoacrylate adhesive (i.e. Gorilla Super Glue) to the bottom groove, and gently tap the plank into place using a pull bar and hammer. Next, apply enough strips of painter's tape across this seam to hold the joint securely in place until the adhesive sets. Using a clean, soft cloth, carefully clean up any excess adhesive on the surface of the planks.

DISASSEMBLY

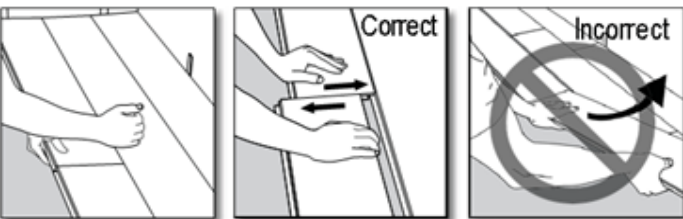

Separate the whole row by carefully lifting up and separating the whole row. Fold up and release the whole long side of the row, being very careful not to allow the planks to bend downward at the end seams! This could damage the locking mechanism of the plank!

NOTE The 5G Fold may become misaligned in the removal process. These may be re-aligned manually prior to reinstallation.

Disassemble the panels by sliding them apart horizontally at the end seams. **Do not fold connected planks upwards!**

COMPLETION

1. Protect all exposed edges of the flooring by installing wall molding and/or transition strips. Make sure that no plank will be secured in any way to the subfloor.

2. For wet areas such as bathrooms caulk the perimeter of the floor with a flexible silicone caulk.
3. Protect the finished flooring from exposure to direct sunlight to reduce fading and thermal expansion.
4. Cutting resilient product into a fine point may lead to delamination. Use an ethyl cyanoacrylate based glue to help fuse the resilient point together. Be sure to clean all glue from the top surface immediately. Alcohol based glues may cause resilient products to swell.
5. Adhering tape to the surface of your resilient flooring could damage the surface.
Do not use tape to secure floor protection directly to the floor during construction or renovation. Instead, adhere tape to the material used to protect the floor and secure it to the base molding along the wall. A material such as ram board can also be used to protect your flooring.